



Instruction Manual

MANWP16-6 REV G 11/04/17

**MODEL: WP16-6
16L RECHARGEABLE BACKPACK SPRAYER**



SILVAN AUSTRALIA PTY. LTD.

ABN 48 099 851 144

VICTORIA (HEAD OFFICE)

244- 264 Greens Rd,
Dandenong South, 3175 Australia
Telephone: +61 (03) 9215 2700
Facsimile: +61 (03) 9215 2701
www.silvan.com.au

NEW ZEALAND

22 Sunshine Avenue
Te Rapa, Hamilton, 2001 New Zealand
Telephone: +64 (07) 8496033
Fax: +64 (07) 8496070
www.silvannz.co.nz

**FOR SERVICE SUPPORT PH 1300 745826
info@silvanaust.com**

Safety Instructions



Before attempting to operate or install the sprayer carefully read and take note of the following safety warnings.

Failure to comply with these warnings may result in serious injury or death.

Warning! This sprayer is designed and manufactured solely for the purpose of applying agricultural chemicals to plants. Under no circumstances may it be used for any other purposes.

Warning! Prior to using the sprayer all operators must read and fully understand the contents of this instruction manual, all safety information fitted to the sprayer and any other instructions for associated equipment or chemicals.

Warning! Never allow an inadequately trained person to install or operate the sprayer.

Warning! Do not spray or pump flammable liquids.

Warning! Refer to the chemical manufacturer's label for correct use and safe handling instructions of chemicals before filling or using the sprayer. Always wear the recommended safety clothing and equipment when handling chemicals and operating the sprayer. Ensure that all operators and associated personnel are familiar with the legal regulations and codes of practice that apply to the safe use, storage and disposal of spray chemicals.

Warning! Exercise care to ensure proper stability when carrying or operating in hilly and uneven terrain, particularly if the ground is wet or loose. Wear non-slip shoes.

Warning! Before carrying out maintenance work, wash the sprayer thoroughly to remove all toxic chemicals that may contaminate the sprayer. Wear appropriate safety clothing and equipment when carrying out maintenance. Do not clear blocked nozzles by blowing out with your mouth.

Warning! Never point the spray gun at any person or any part of the human body.

Warning! Dispose of empty chemical containers and chemical residues in accordance with the instructions supplied by the chemical manufacturer.

Warning! This sprayer places weight directly on the back and shoulders as well as indirectly on the lower body. If you have or suspect you may have any physical condition that may be aggravated by carrying weight on your back then do not use this product.

BATTERY CHARGER WARNINGS

Warning! When using the battery charger ensure it is a dry environment and do not leave the charger where it may rain.

Warning! The battery charger is not to be used by persons (including children) with reduced physical, sensory or mental capabilities, or lack of experience and knowledge, unless they have given supervision or instruction.

Warning! Children should be supervised not to play with battery charger.

Warning! The battery charger is only intended to accept 7.4VDC Lithium Ion Battery pack from SILVAN AUSTRALIA PTY LTD having max. rated capacity of 4Ah.

Warning! Do not use this charger to charge Non-Rechargeable battery packs.

Warning! The supply cord cannot be replaced. If the cord is damaged the battery charger should be scrapped

Specifications

GENERAL

This knapsack sprayer has been designed and manufactured solely for the purpose of applying agricultural and horticultural herbicides and insecticides to plants.

DIMENSIONS

Length	260 mm
Width	345 mm
Height	550 mm
Weight (dry)	5kg (without charger)
Nominal capacity	16 Litres

To calculate the weight of the sprayer, add 1kg to the dry weight for every litre of water. E.g. The laden weight of the sprayer with 16L of water is 21kg.

PUMP

6 Volt DC Diaphragm pump with an 'On-Demand' pressure sensing switch that starts the pump when pressure drops below 30-35psi and stops the pump at 35-40psi when the handgun is switched off.

Flow:	1.5 L/min open flow
Valves:	Viton
Diaphragm:	Santoprene
Duty Cycle:	Intermittent
Battery Run Time:	Up to 5 tanks of spraying per charge.

TANK

16L blow moulded translucent polyethylene tank, U.V. stabilized and impact resistant with calibrated fill mark moulded into the tank. Shoulders straps attaching points.

SPRAYLANCE

Poly trigger gun with 550mm lance and adjustable nozzle.

FILTRATION:

1. Basket strainer under lid
2. Internal suction tank filter
3. Filter in spray trigger handle.

BATTERY

7.4V, 4Ah (Amp/hour), Lithium Ion

Note: Battery should be charged before first use.

FUSE LINK

Specification: 6A, 3AG.

BATTERY CHARGER





240V AC battery charger. 8.4VDC, 1A

Approximate charging time 6 hours

Red indicator light = Charging

Green indicator light = Charged (Also Green when charger not connected to battery)



Battery Charger	
Tradename / Brandname:	SILVAN
Model No:	W&T – AD12W084100
Input:	100 - 240V~, 60/50Hz, 0.4A - 0.2A
Output:	8.4VDC, 1.0A
Class II symbol:	
Symbol for indoor use only:	
Symbol SMPS incorporating a Shortcircuit proof isolating transformer (inherently or noninherently)	
Symbol SMPS:	
Fuselink	 T1.0A
Charger for 7.4V Lithium Ion Battery pack from SILVAN only.	
Before charging, read instructions.	
Do not expose to rain.	

Associated Transformer T1 in the battery charger	
Manufacturer	W&T
Model No:	CH24WA-08
Pri:	100 - 240V~, 60/50Hz, 0.4A - 0.2A
Sec:	12.5VAC, 1.0A.
Internal operating frequency	75 kHz max.
Class II symbol:	
Only intended to be used with the SILVAN Battery Charger (Model No: W&T – AD12W084100)	

Installation

GUN ASSEMBLY

Fit the spray lance to the gun ensuring the O-Ring is fitted. Fit the 45 degree elbow and nozzle to the tip of the lance again insuring the O-ring is in place.

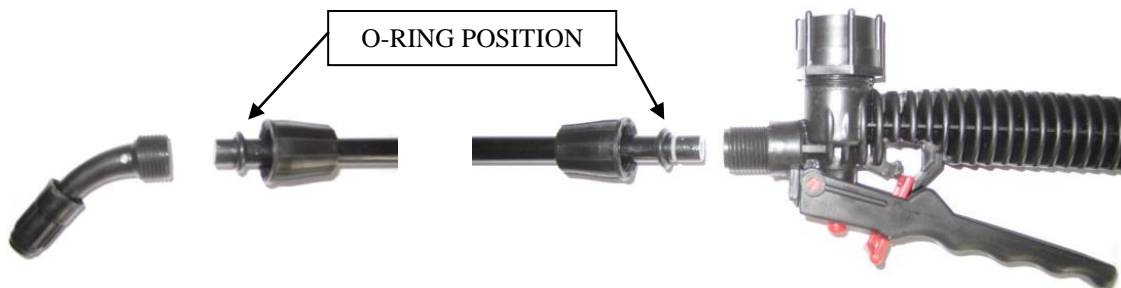

ADJUSTING SHOULDER STRAPS

The shoulder straps are supplied fitted. If they become disconnected reattach as shown in the pictures below.



Operation

CHARGING THE BATTERY

Note: The battery should be charged before first use.

Check the pump switch is in the off position. Plug the battery charger into a standard 240 Volt powerpoint. Connect the coaxial plug on the output lead to the socket on the sprayer.

Recharging time depends on the state of the battery. A completely discharged battery takes up to 6 hours to recharge.

After recharging for general safety reasons turn off the charger, particularly in an unattended area.

WARNING: Only use the genuine battery chargers supplied by Silvan Australia. Non genuine chargers may apply incorrect charge to the battery.

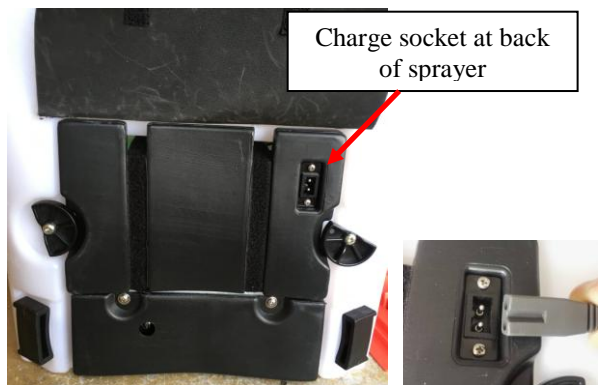

CHARGE INDICATOR LIGHT (on Charger)

Take note of the following when charging to trouble shoot any technical difficulties.

GREEN = Battery Charged

RED = Battery Charging

GREEN = Charger not connected to battery (or loose connection, blown fuse)

FILLING THE TANK AND ADDING CHEMICAL

Warning : Before using the sprayer for the first time or adding chemical check the operation and function of the sprayer with clean water

Check that the battery is charged, the filters are clean and all fittings, hoses and gun connections are tight.

Partly fill the sprayer before adding chemical. Always use clean water to prevent blockages and ensure chemical function is not inhibited.

Add the chemical according to the directions on the chemical container following all safety and protective equipment recommendations.

Do not use wet powders or chemicals that must remain suspended in solution and require agitation. Only use chemicals or dyes that fully dissolve.

Do not use a sprayer that has been used to spray herbicides for insecticides or nutrients unless the sprayer has been thoroughly cleaned including neutralizing the herbicide according to the manufactured directions if required.

OPERATING THE PUMP

The pump has an off switch located on the base (bottom) of the sprayer. The pump will also switch off automatically when the spray lance is not in use, however when the tank is empty this does not function. When leaving the sprayer unattended always switch the pump switch off.

SWITCH POSITION 0 = OFF, 1 = ON



OPERATING THE SPRAYLANCE

Depress the trigger to operate the lance. The nozzle on the end of the lance can be adjusted by twisting to create a solid stream or a hollow cone shape for misting. For herbicide sprays do not use a fine mist as the mist can easily be carried off target by the wind and kill or damage other plants.

Maintenance

To avoid chemical contamination wear appropriate protective equipment including gloves whenever maintenance is carried out; turn off the pump and depress the trigger on the spray lance to dissipate any pressure.

After spraying is completed, drain unused chemicals from the tank. Rinse the tank with clean water then operate the sprayer with clean water in the tank to clean out the pump, hose and spray lance. Do not leave chemicals in the tank as they may crystallize or form solids and block in pump, spray lines, nozzle or filters.

If heavy frosts are experienced, run the sprayer until the pump and spray lines are dry. This will prevent water freezing in the pump and damaging the sprayer.

Warning ! Dispose of unused chemical and water used for rinsing in a manner that will not endanger people, animals or the environment in accordance with local regulations and the handling and disposal information available from the Chemical manufacturer.

CLEANING THE FILTERS

The knapsack has 3 filters that require cleaning. Always use clean water and rinse out the sprayer after use to avoid filters becoming clogged.

1. Basket strainer under lid. Clean when dirty.
2. Filter in gun handle. Unscrew the hose connection to the gun and withdraw the filter using a pair of pointy nose pliers and clean.
3. Suction filter inside tank. Unscrew the filter using a pair of pliers grasping it on the hexagonal brass section against the tank. Withdraw the filter, disassemble and clean. When reassembling do not over tighten

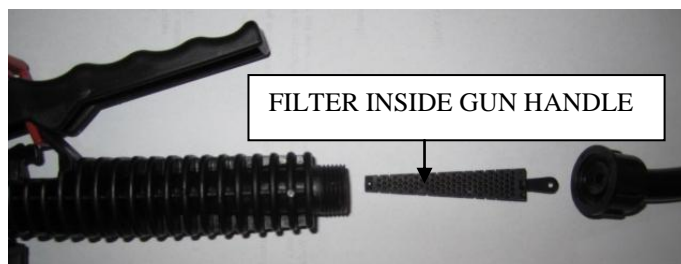

Maintenance

USING THE VACUUM PUMP

If the sprayer has not been used for some time or has been left with chemical in it then the pump valves may become stuck. If this happens the pump will run but no liquid is pumped.

If this happens you can use the hand operated vacuum pump to prime the pump as follows:

1. Empty the tank and spray hose of liquid
2. Make sure the power switch on the knapsack is off
3. Connect the hand pump as shown in the pictures below and lock the trigger on

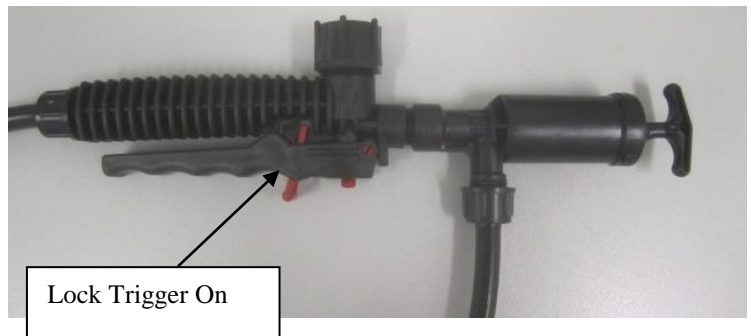

4. Pump the handle to draw some air and unstick the pump valves
5. Clean the vacuum pump after use.

Trouble Shooting Guide

Some times when accessing the battery or changing a fuse it is possible to accidentally disconnect a cable stopping the sprayer from operating.

The Battery box on the back of the sprayer includes the charging socket, fuse and battery. Use the diagram (right) and trouble shooting instructions to resolve basic difficulties.

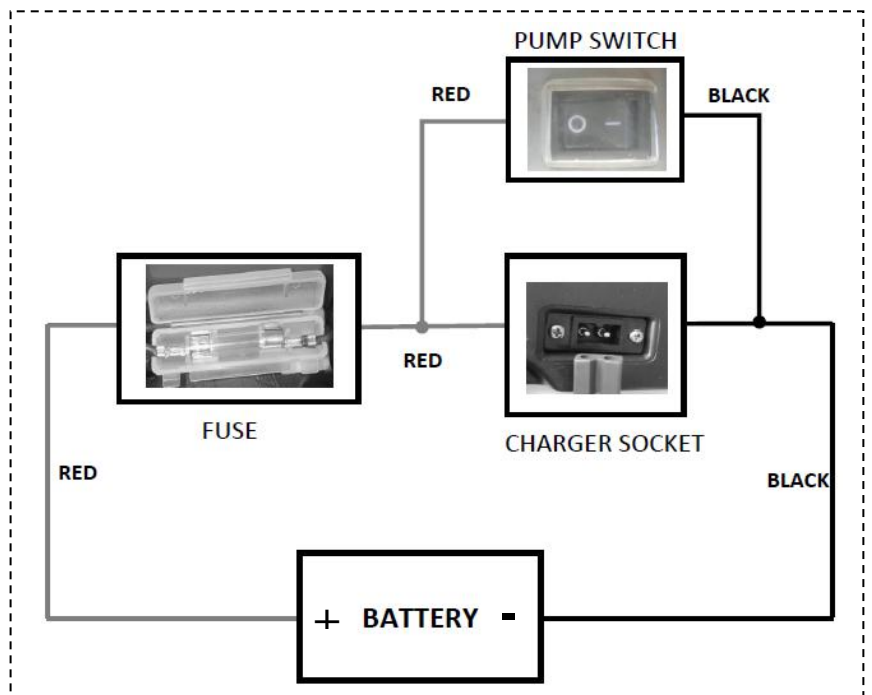
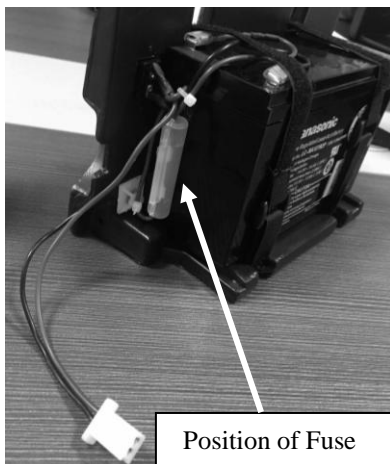

Trouble Shooting Guide

TROUBLE SHOOTING GUIDE	
Symptom	Remedy
Pump does not operate	<ul style="list-style-type: none"> • Ensure battery wires are connected to battery properly. • Check the inline Fuse in the power loom (Fuse is Blown or cable to fuse is loose/ disconnected). • Check battery is not flat or charger has not been working.
Battery charger is not charging or battery related issues.	<p>Connect Charger to 240V Power socket, Charger Indicator light should be Green when not connected to sprayer</p> <ul style="list-style-type: none"> • Connect to charge socket on sprayer. Charge indicator light will change from GREEN to RED when charging. • If Light remains GREEN when connected Battery is charged. Turn on pump Light should change RED to indicate charging (no problem) • If Light remains GREEN when pump on connection in <u>Battery Box</u> is loose. Check all terminals are fitted and fuse not blown. If fuse OK rattle fuse connector to check it part is loose.
Pump operates but cycles or continues to run when the wand handle is released	<ul style="list-style-type: none"> • There is a slow leak of liquid. Check all connections. • The tank is empty or the suction line is not fully immersed.
Pump operates with no flow rate or reduced flow	<ul style="list-style-type: none"> • The pump will not prime unless the gun trigger is on. • Check filter, nozzles and spray lines for blockage. • Pump valves may be stuck or blocked. Use the hand air vacuum pump according to the instructions in manual. Alternatively apply a small amount of pressure to the suction line by placing a garden hose over the suction hose inside the tank while the pump is running.